

Acoustiroc®

GUIDE D'INSTALLATION

POSES HORIZONTALES

HORIZONTAL INSTALLATION

GUIDE



- Lire attentivement la notice avant de commencer l'installation
Read the instructions carefully before starting the installation
- Les murs supports doivent être lisses, plans, propres et secs
Supporting walls must be smooth, level, clean and dry
- Veuillez utiliser les équipements adéquats (outils et protection)
Please use the appropriate safety equipment and tools

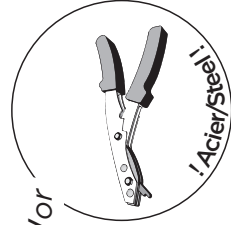
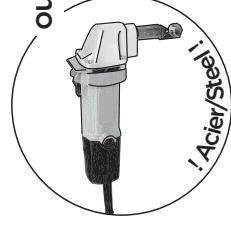
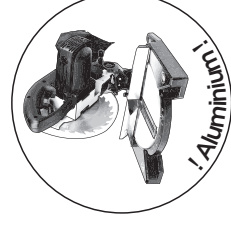
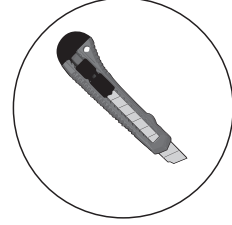
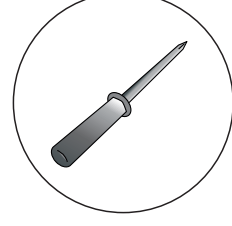
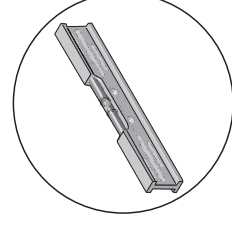
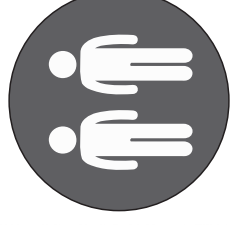
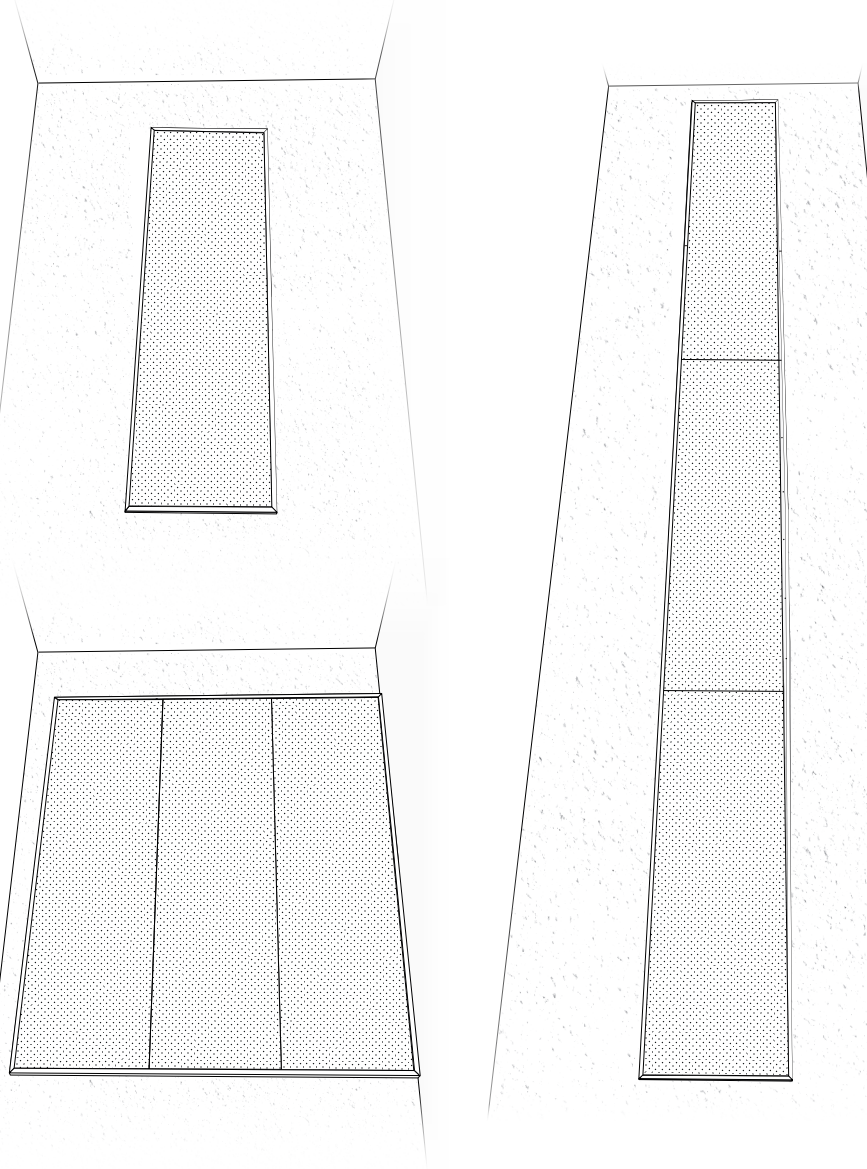

ou / or

! Aluminium

! Acier/Steel

! Acier/Steel

Composants système Acoustiroc® Acoustiroc® system components

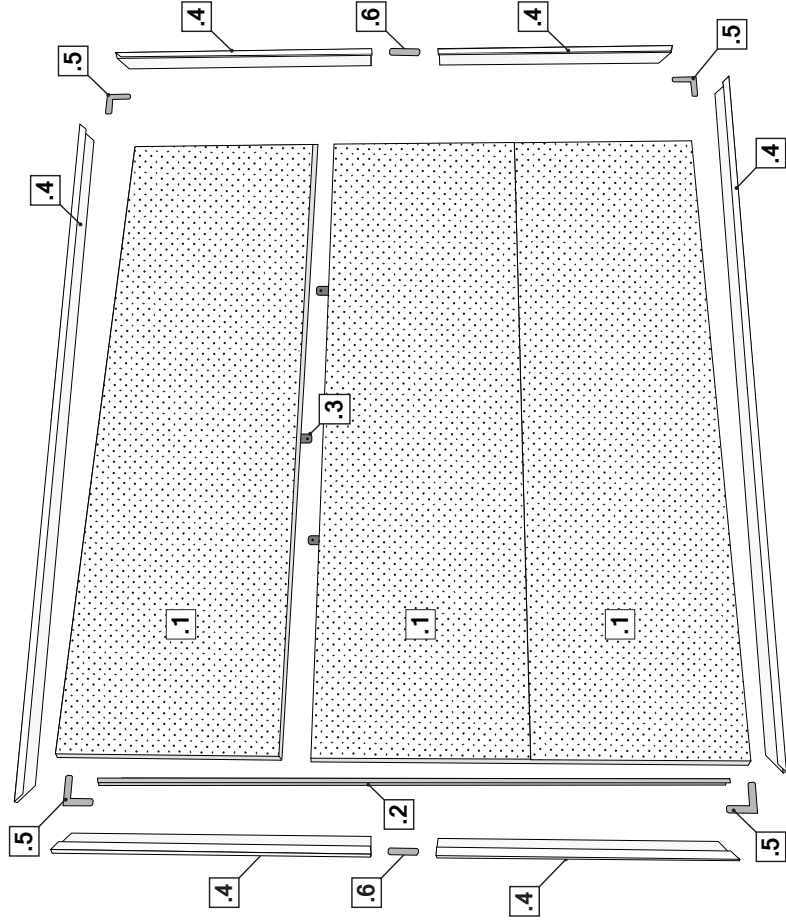

Composants Système Acoustiroc® / Acoustiroc® System components			Conditionnement Packaging
N°	Désignation Designation	Quantitatif Quantity	Panneaux Panels Colis /Parcel/ n°1,1
.1	Panneau / Panel 790x2700x40 mm	Selon configuration As required	2 panneaux par colis 2 panels per parcel
.2	Cale / Wedge 13x38x13 Lg 1580 mm	0,5 par panneau 0.5 per panel	1 cale par colis 1 wedge per parcel
.3	Clip anti-désaffleur pour pose verticale / Clip for vertical installation	1 à 2 par jonction 1 or 2 per junction	4 clip par colis 4 clips per packet
.3	Clip de fixation murale pour pose horizontale / Clip for horizontal installation	3 par panneau 3 per panel	6 clip par colis 6 clips per parcel
.4	Profil Aluminium / Aluminium Profile 65x46x30 Lg 2800 mm	Selon configuration As required	6 unités par colis 6 units per parcel
.5	Raccord d'angle / Angle connector	4 par cadre 4 per frame	6 unités par colis 6 units per parcel
.6	Raccord droit / Straight connector	Selon configuration As required	6 unités par colis 6 units per parcel

Entretien & Nettoyage Cleaning & Maintenance

Acoustiroc® nécessite peu d'entretien. Différents types de nettoyages sont possibles :
Acoustiroc® requires very little maintenance. Please follow these cleaning rules:

- Pour enlever la poussière, utiliser une brosse douce ou un aspirateur avec un embout non abrasif.
To remove dust, use a soft brush or vacuum cleaner with a non-abrasive tip.
- Pour les traces de crayon, utiliser une simple gomme.
For pencil traces use a simple eraser.
- Pour les tâches grasses, utiliser un chiffon légèrement imbibé d'un tensioactif en prenant soin de ne pas mouiller l'isolant.
For greasy stains, use a cloth slightly moistened with a surfactant taking care not to wet the insulation.
- Pour les autres tâches ou salissures, utiliser un chiffon ou une éponge humide en prenant soin de ne pas mouiller l'isolant.
For other stains or soiling, use a damp cloth or sponge taking care not to wet the insulation.
- Ne jamais utiliser de produits abrasifs.
Never use abrasive products.

1- MESURE & PREPARATION / PREPARATION & MEASUREMENT

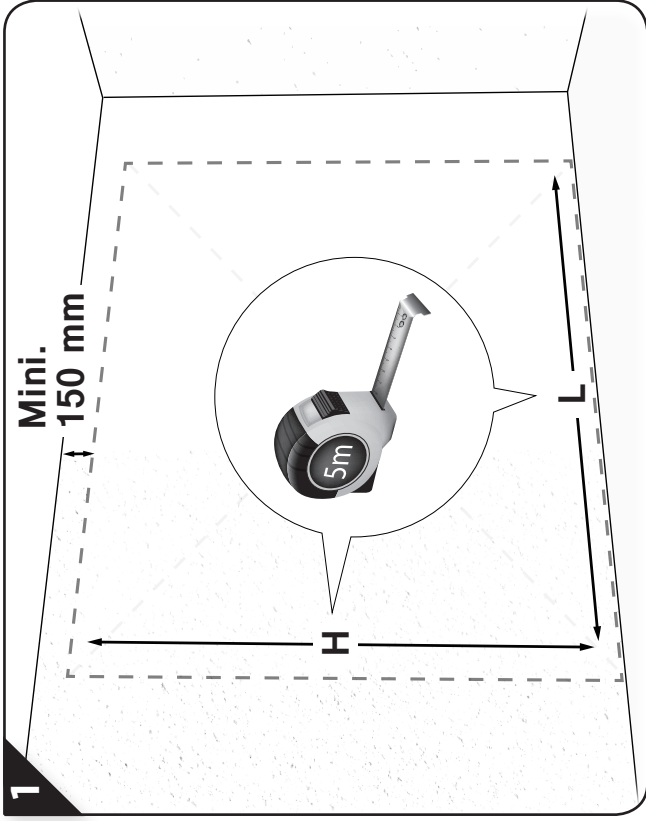

N = nombre de panneaux / n° of panels
 ℓ = longueur du panneau / panel length

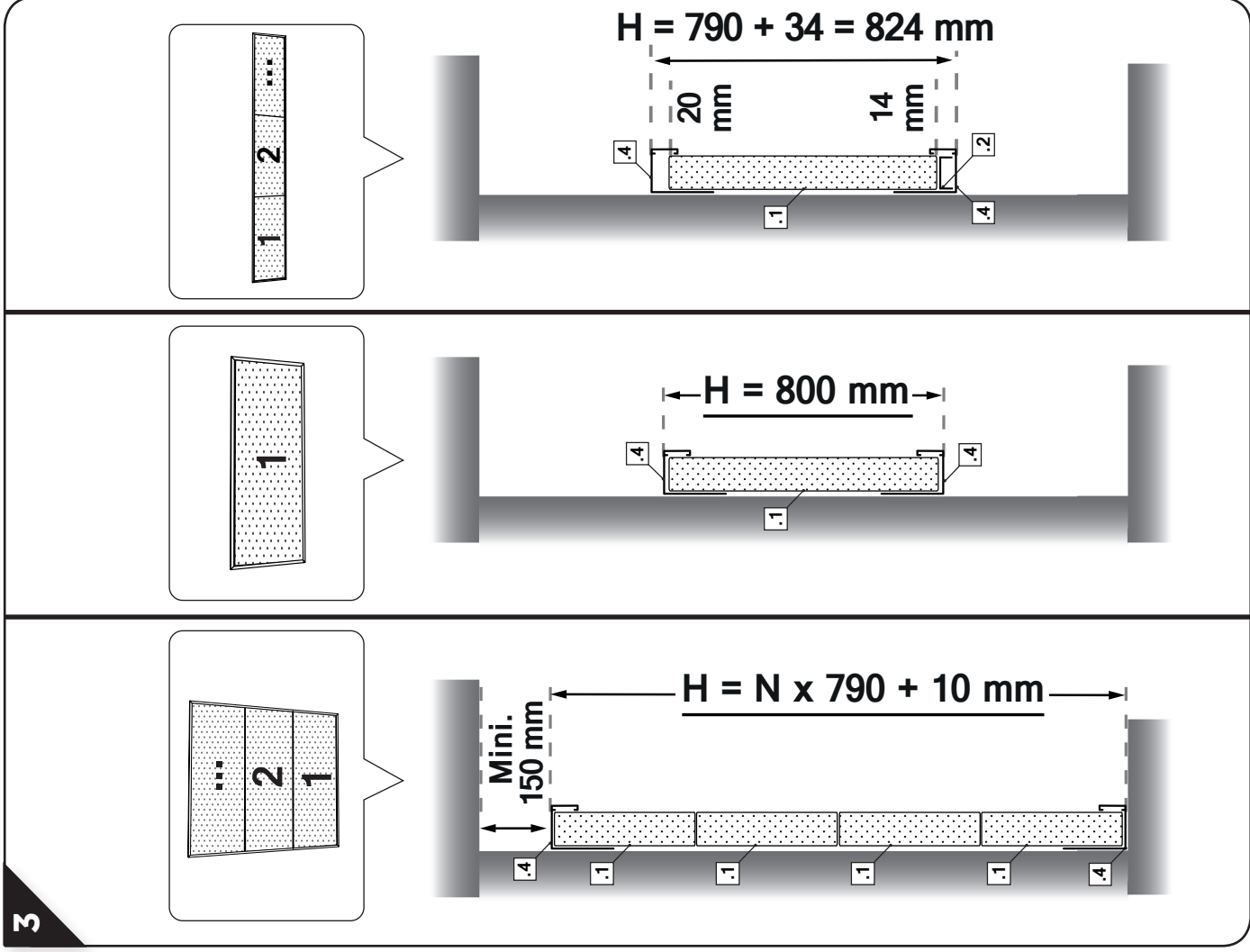
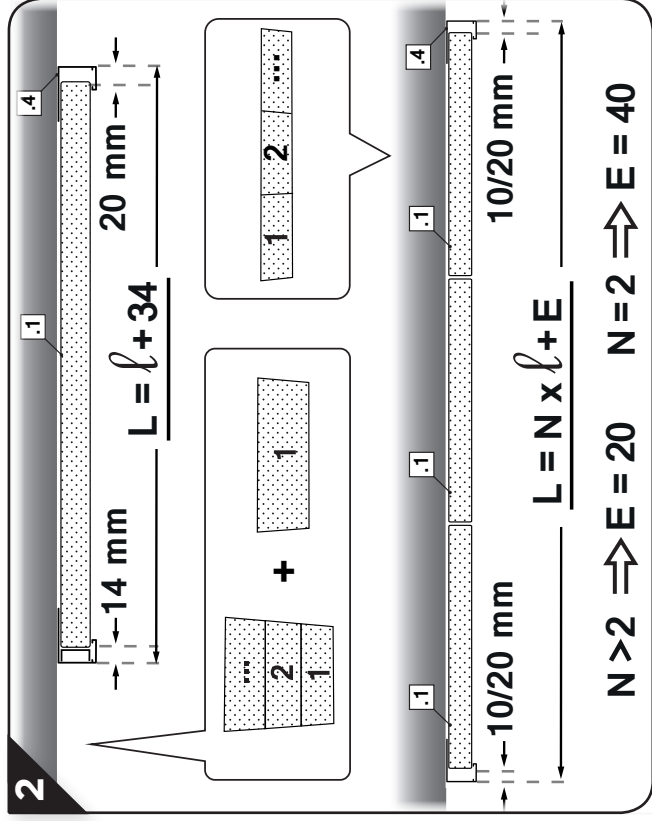

2- DECOUPE & INSTALLATION DES PROFILS / CUTTING & INSTALLING THE FRAME

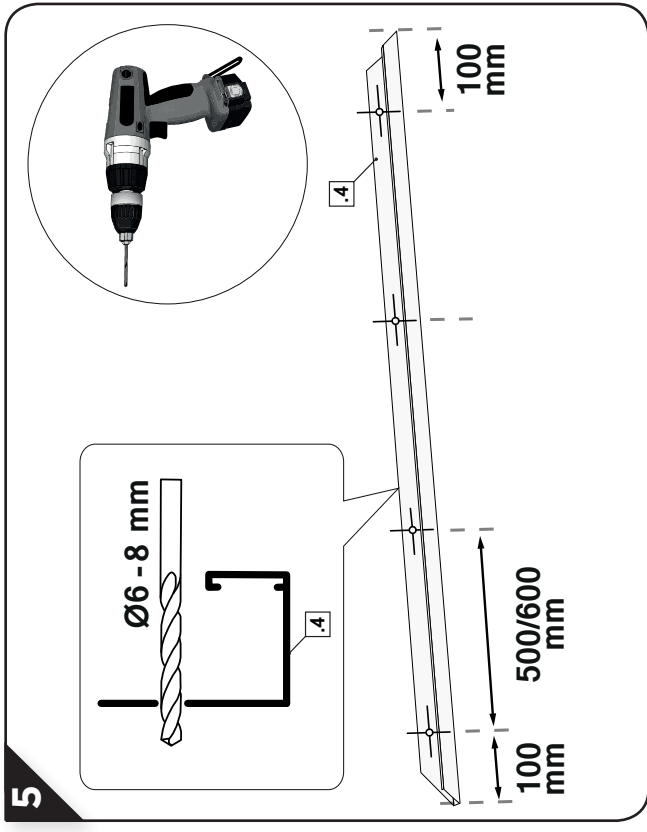
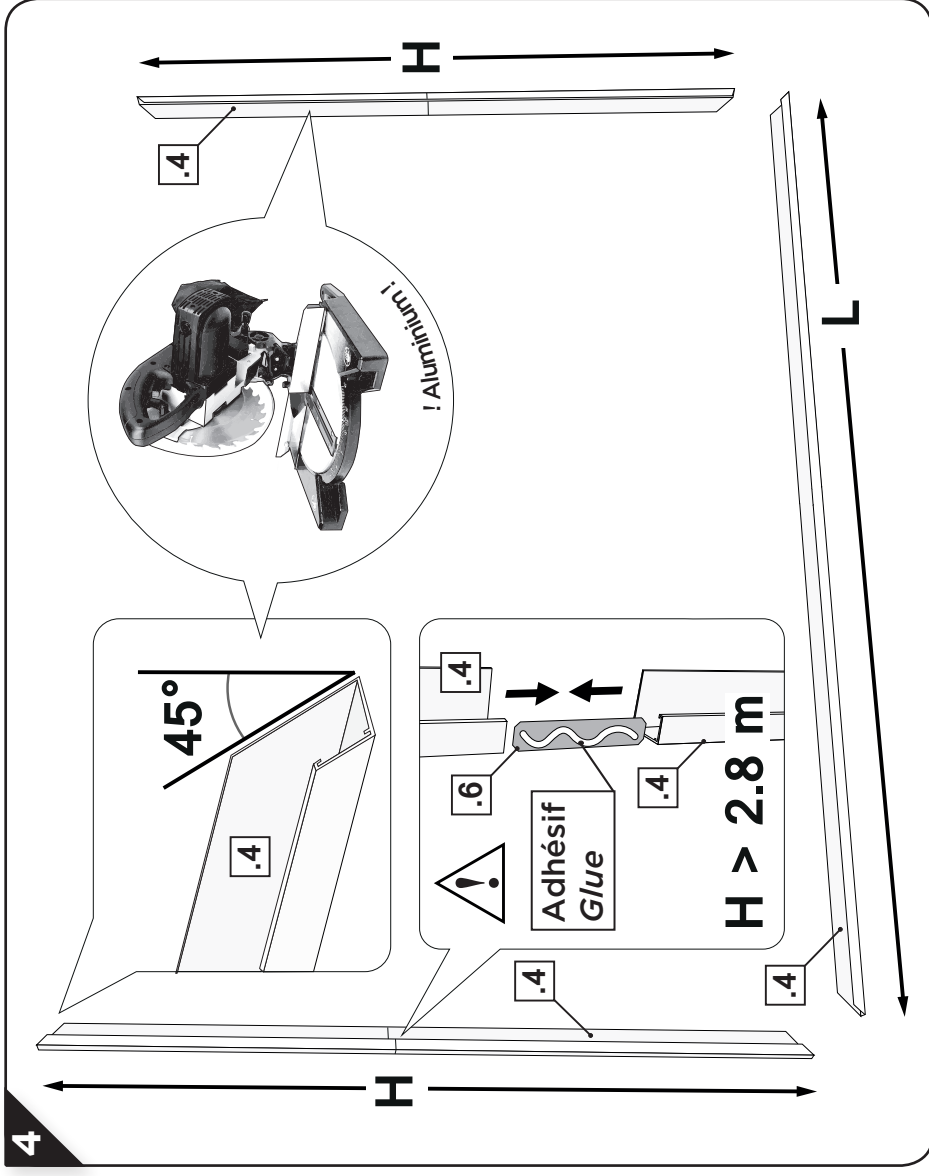

 Lors de la découpe du profil aluminium, commencer par le talon
 When cutting aluminium profiles, start the cut from the heel

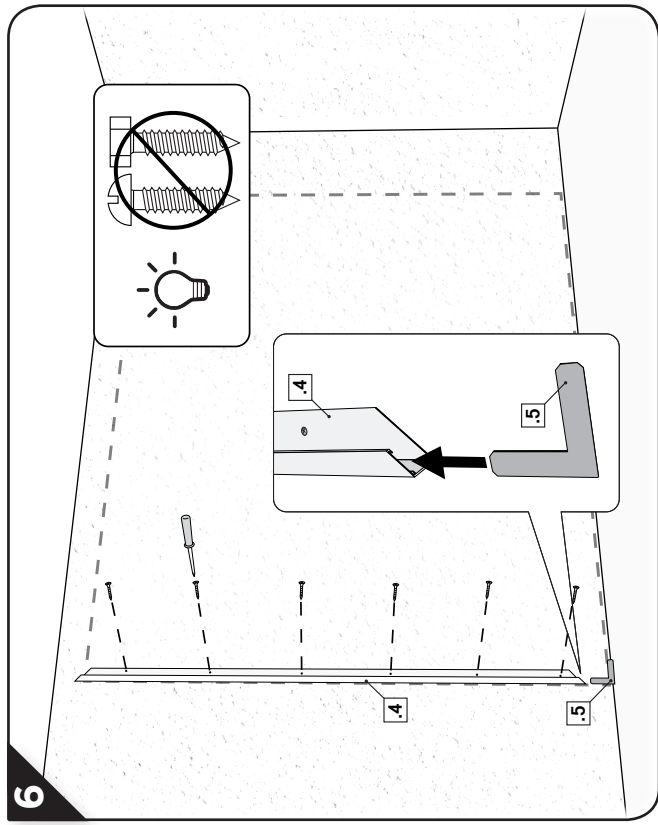

! Prévoir des fixations adaptées au mur support et à la charge à supporter
Use appropriate fasteners for the load and the nature of the supporting wall

- Eviter de mettre des vis avec des grosses têtes afin que les panneaux ne s'accrochent pas dans celles-ci
Avoid using screws with large heads for better panel clearance

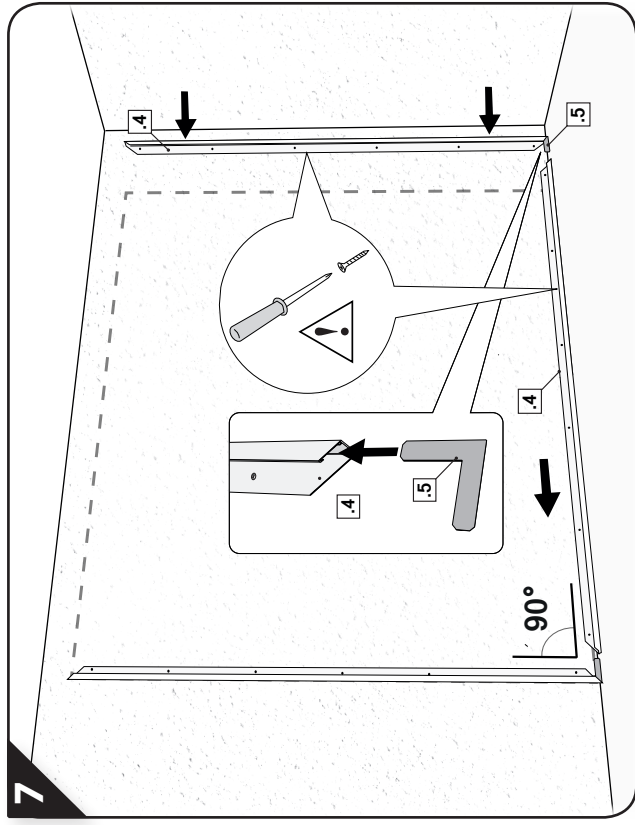

- Pour un raccordement parfait des coupes à 45°, s'aider du profil supérieur horizontal équipé de ses éclisses (voir étape 15) pour bien positionner et visser les profils verticaux
For a perfect miter joint use the upper horizontal profile with its angle connectors (see step 15) to place and screw the vertical profiles

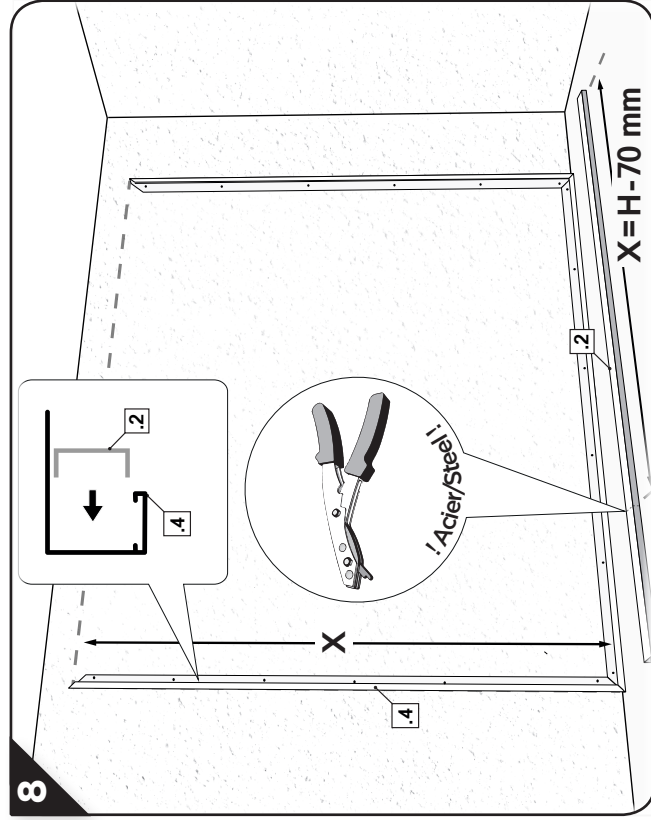

! Superposer les cales à l'avancement de la pose des panneaux (étapes suivantes).
Stack wedges one on top of the other as the panels are installed (next steps)

 Pour pose horizontale en bandeau omette cette étape
For aligned horizontal instalation skip this step.

3- DECOUPE DES PANNEAUX / CUTTING THE PANELS

9

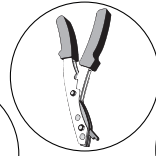
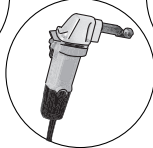

Ou
Or

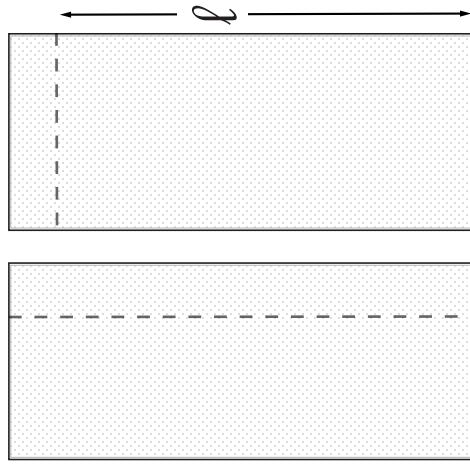
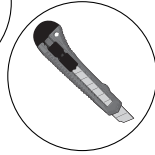

💡 Mettre les côtés
découpés dans
les profils
*Put the cut edges of the
panel under the profiles*

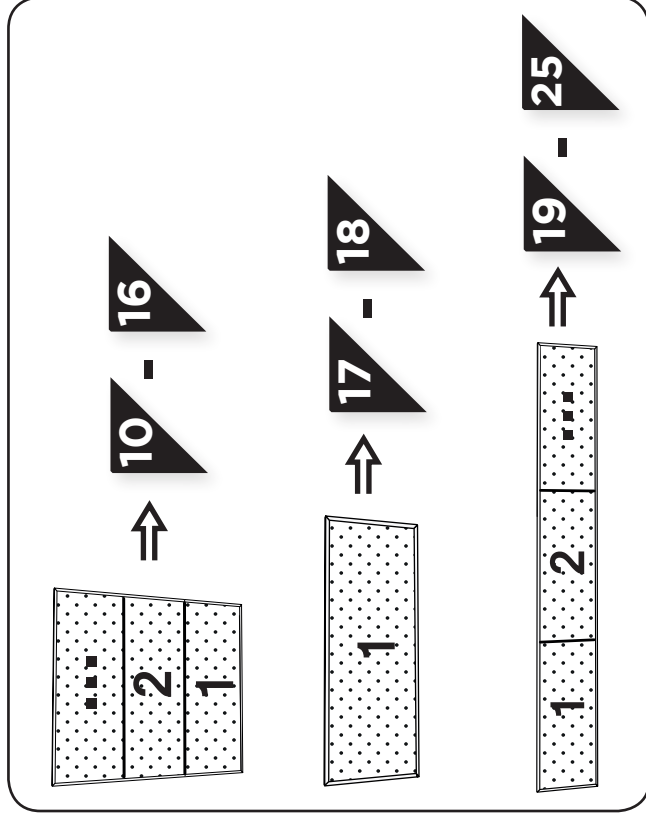

10

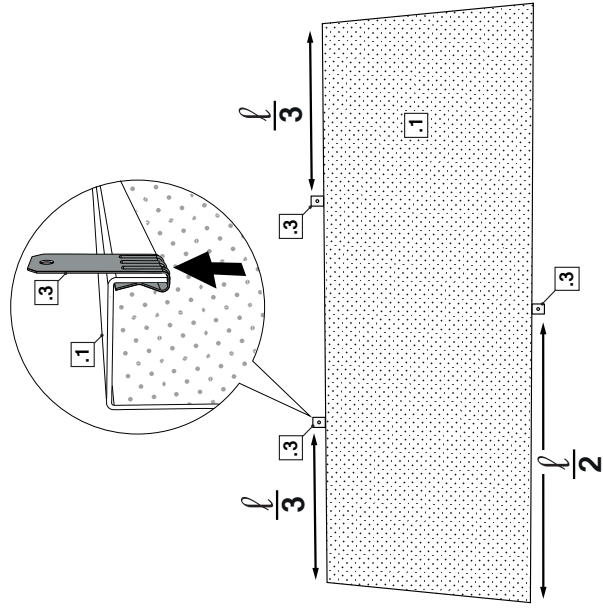

4- INSTALLATION EMPILÉE / STACKED INSTALLATION

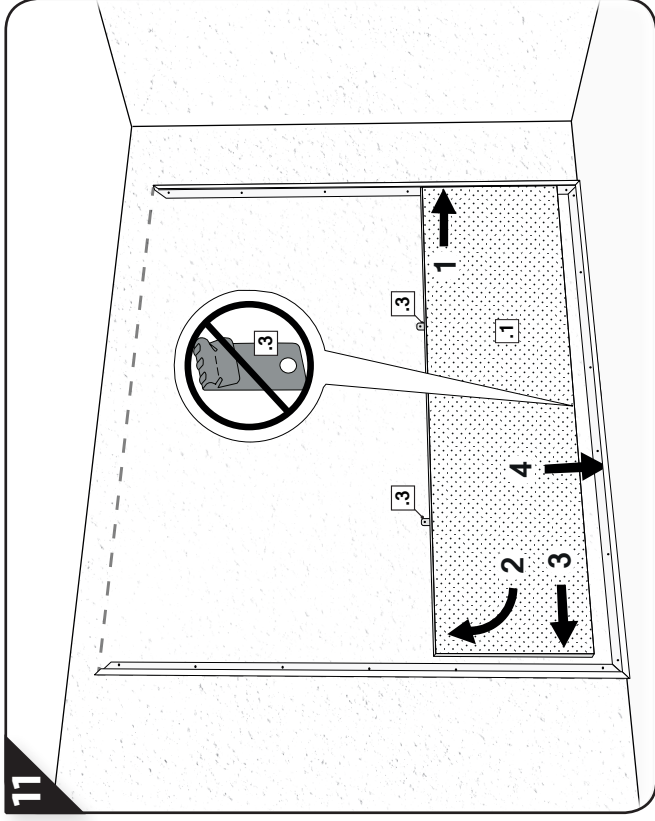

Equiper le premier panneau de 2 clips horizontaux
Use 2 clips on the first panel

⚠ Prévoir des fixations adaptées au mur support et à la charge à supporter : **minimum 25kg de charge admissible par point de fixation**
Use fasteners that are suited to the supporting wall and the load : **minimum 25kg of admissible load per fastener**

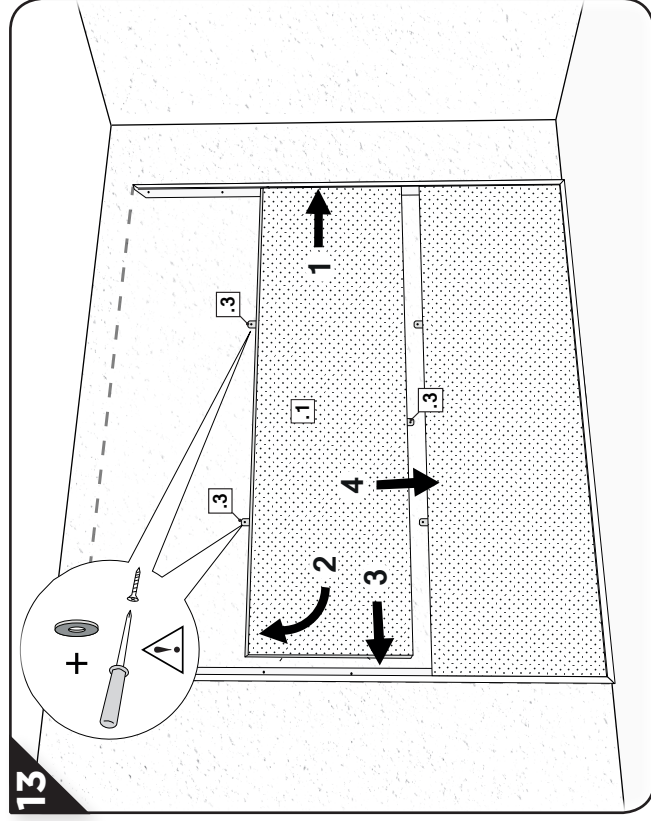

Equiper les prochains panneaux de 3 clips horizontaux
Use 3 clips on the following panels

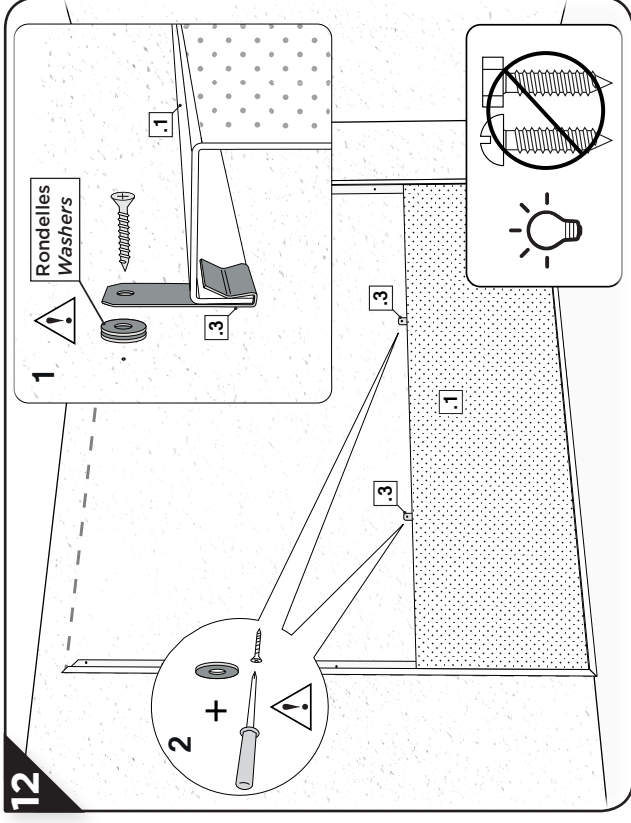

⚠ Ajouter plusieurs rondelles entre les clips et le mur en fonction de l'écartement avec le support avant de les fixer
Place washers between the clips and the supporting wall to achieve flatness of the panel before fastening

⚠ Eviter de mettre des vis avec des grosses têtes afin que les panneaux ne s'accrochent pas dans celles-ci
Avoid using screws with large heads for better panel clearance

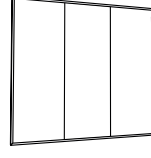

7

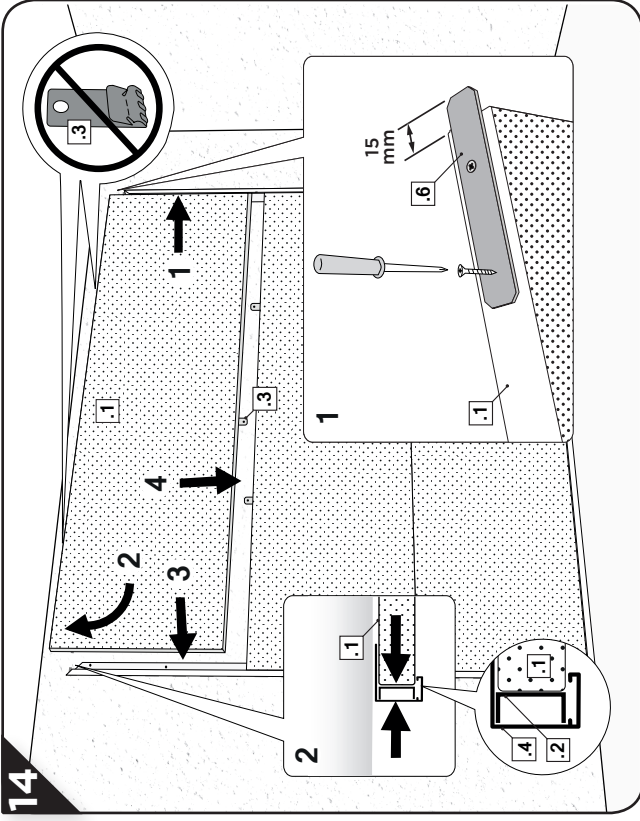

Equiper le dernier panneau du clip inférieur seulement
 Only use the lower clip on the last panel



Mettre les côtés découpés dans les profils
 Put the cut edges of the panel inside the profiles



Éviter de mettre un panneau découpé sur sa longueur dans le profil inférieur
 Avoid putting a panel that has been cut lengthwise into the lower frame profile

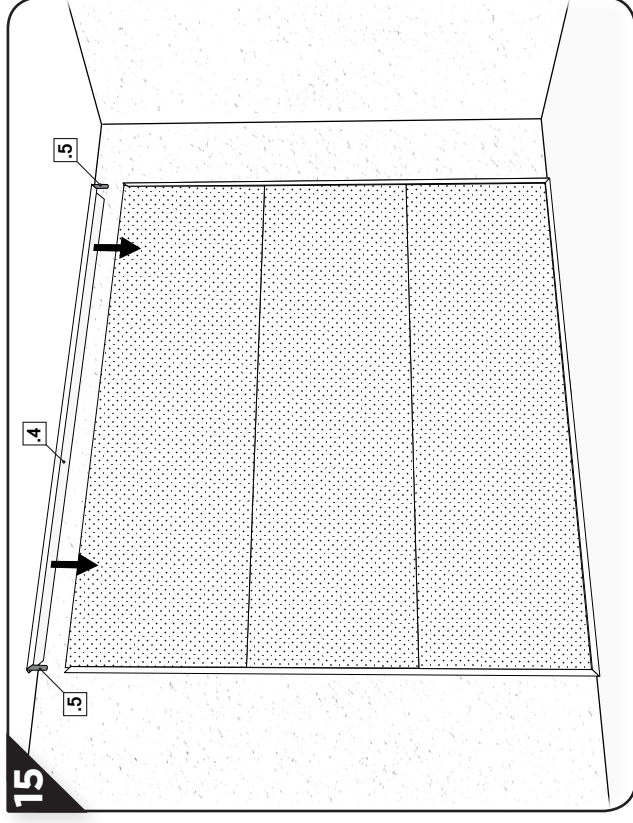
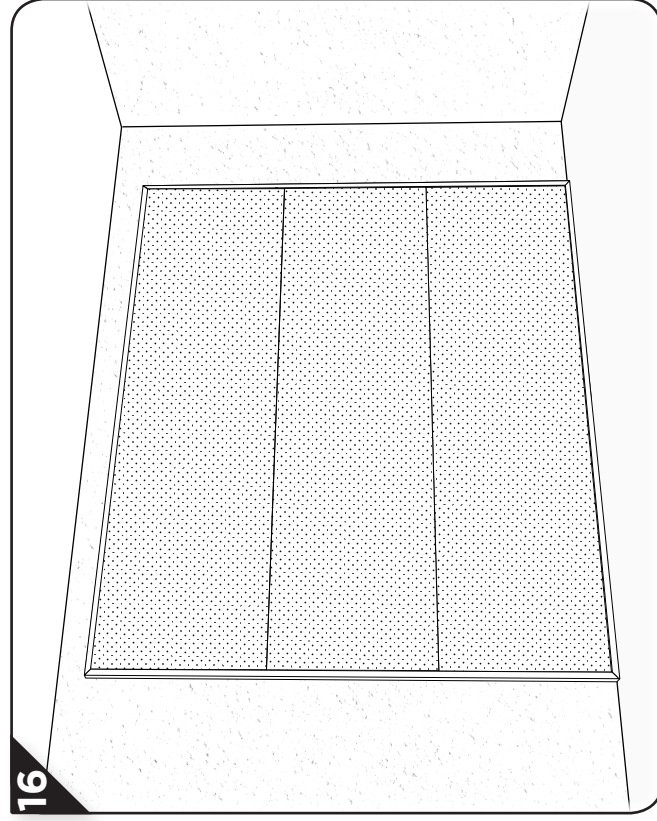

Pour sécuriser le montage prévoir un mastic colle sur le profil supérieur
 To secure the assembly use construction adhesive on the capping profile

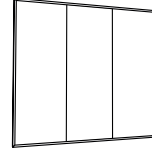

5- INSTALLATION PANNEAU SEUL / SINGLE PANEL INSTALLATION

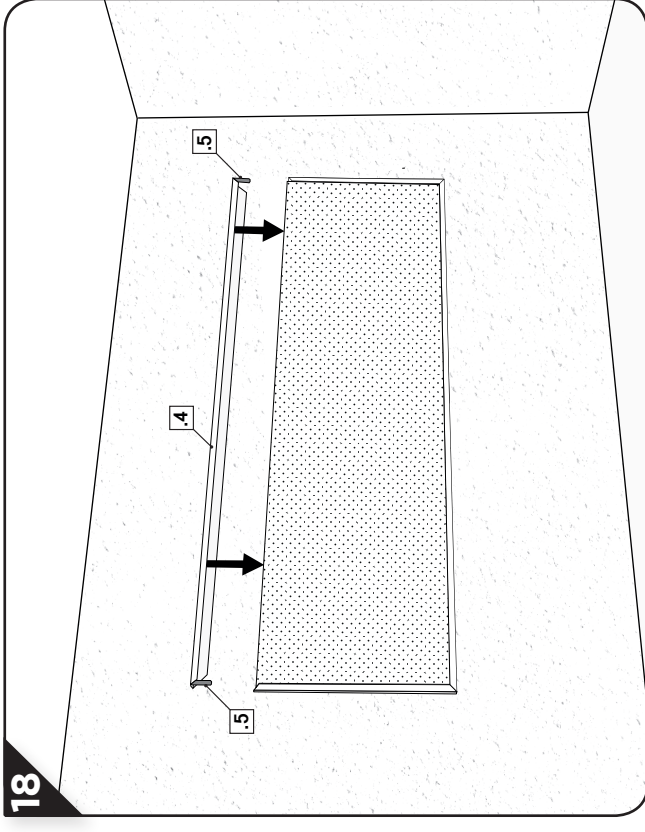
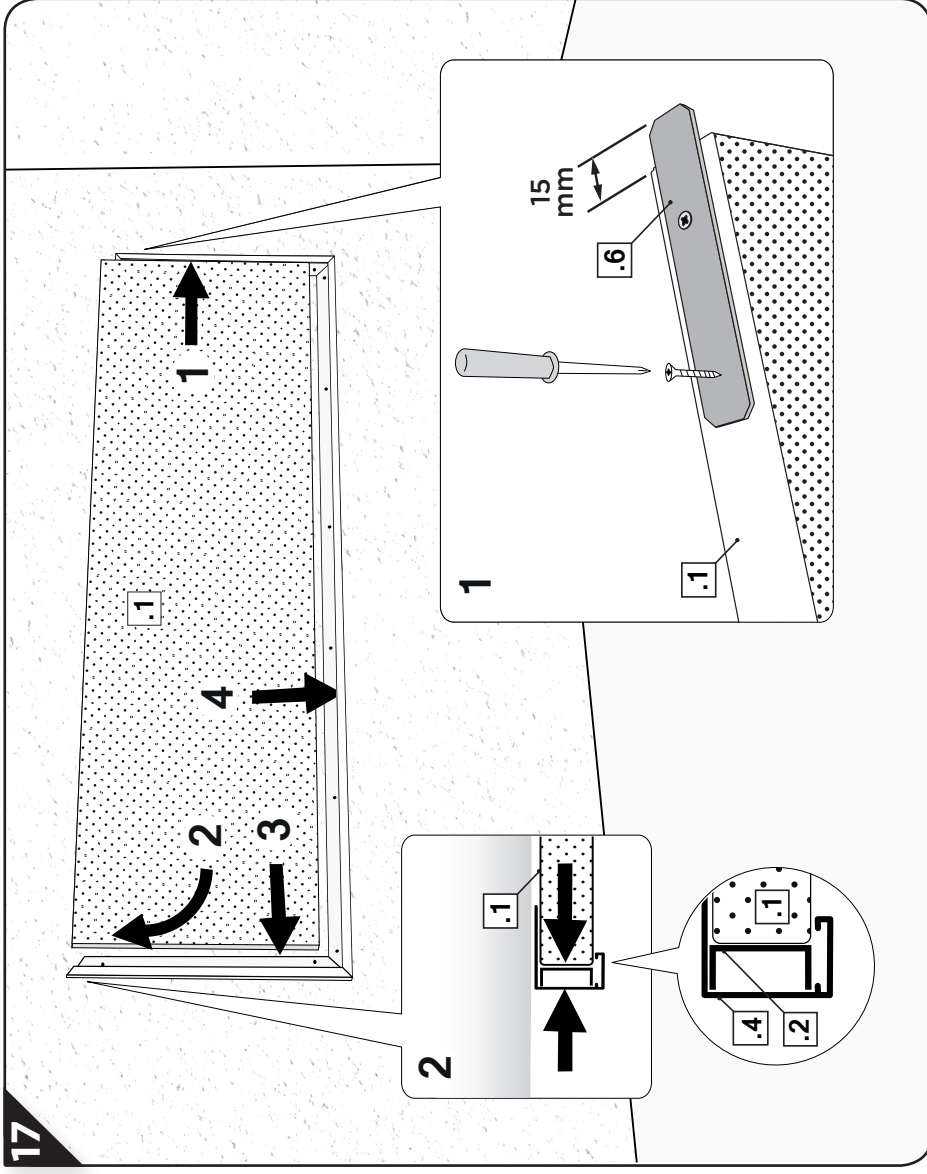

💡 Pour sécuriser le montage prévoir un mastic colle sur le profil supérieur
To secure the assembly use construction adhesive on the capping profile



6- INSTALLATION EN BANDEAU / ALIGNED INSTALLATION

19

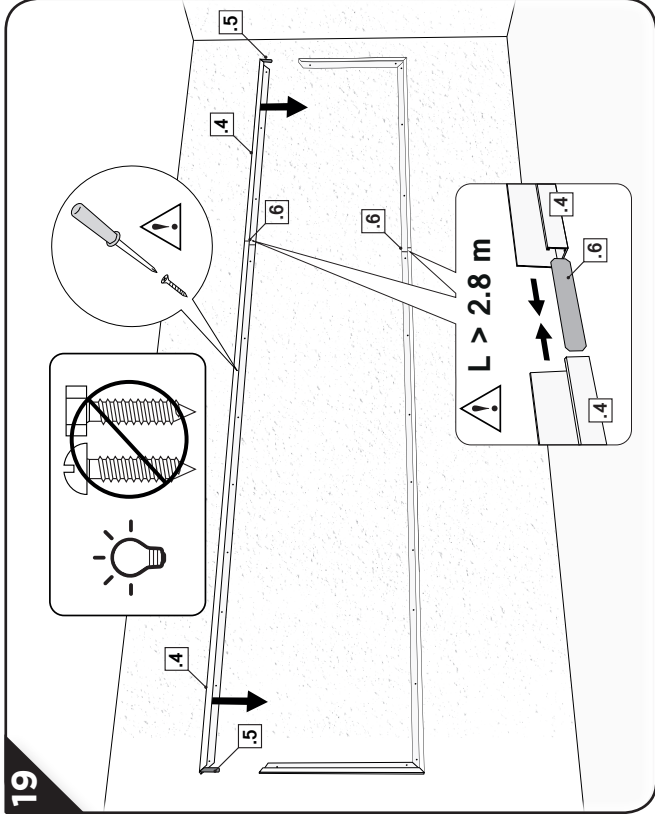

 Prévoir des fixations adaptées au mur support et à la charge à supporter
Use appropriate fasteners for the load and the nature of the supporting wall

 Eviter de mettre des vis avec des grosses têtes afin que les bacs ne s'accrochent pas dans celles-ci
Avoid using screws with large heads for better panel clearance

20

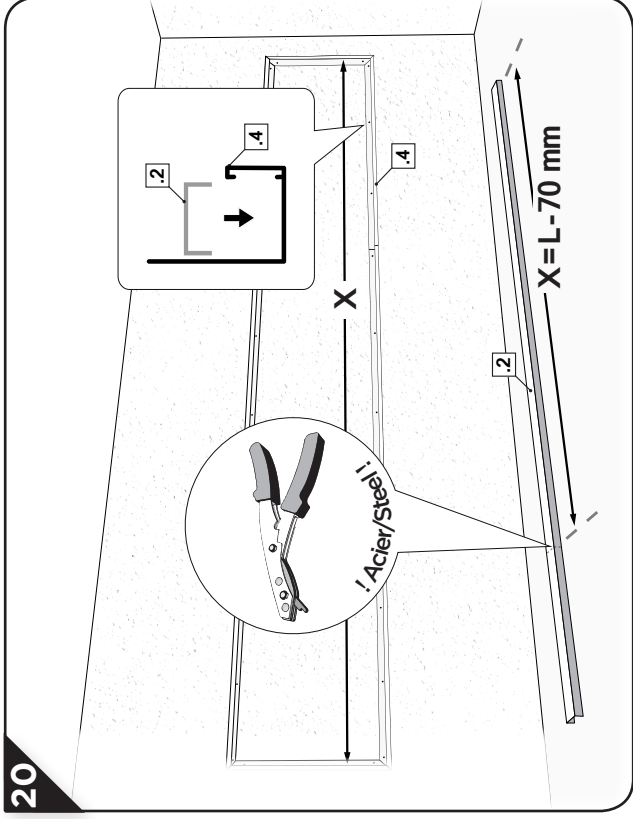

21

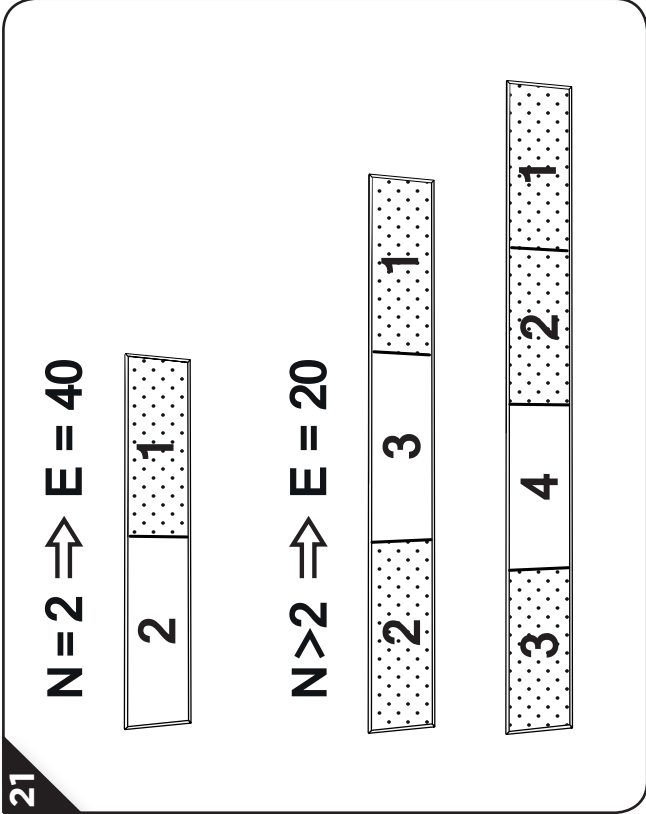

 Placer les premiers panneaux à droite dans le cadre puis l'avant dernier panneau tout à gauche en laissant un espace à sa droite
Place the first panels in the left side of the frame and the second last panel all the way to the left so as to leave a gap to its right

N = Nombre de panneaux / n° of panels
E = voir étape 2 / see step 2



22

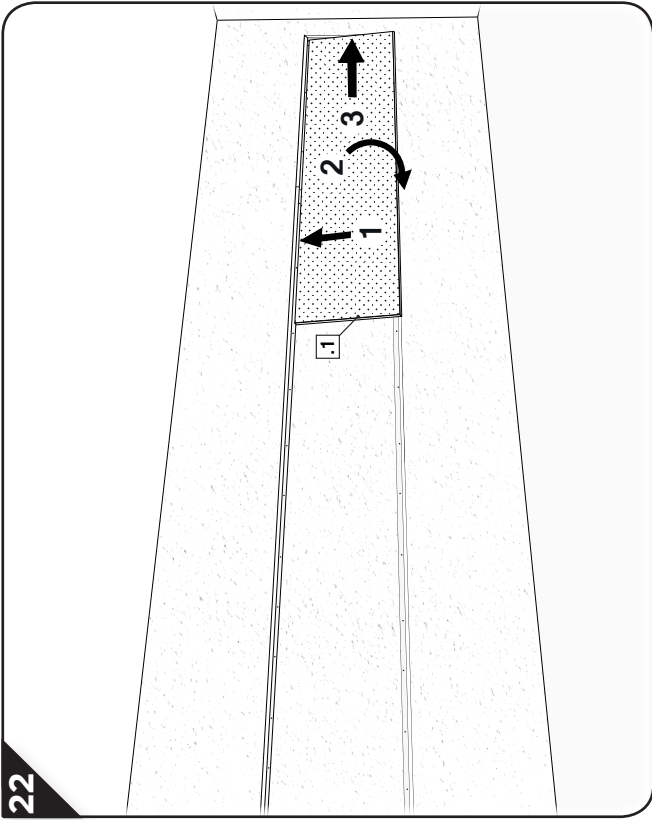

23

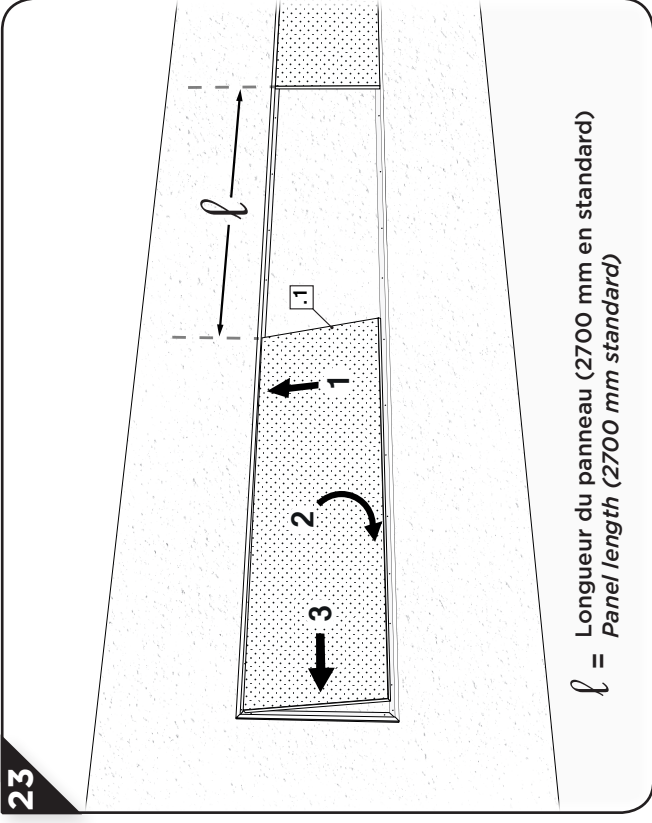

l = Longueur du panneau (2700 mm en standard)
 Panel length (2700 mm standard)

24

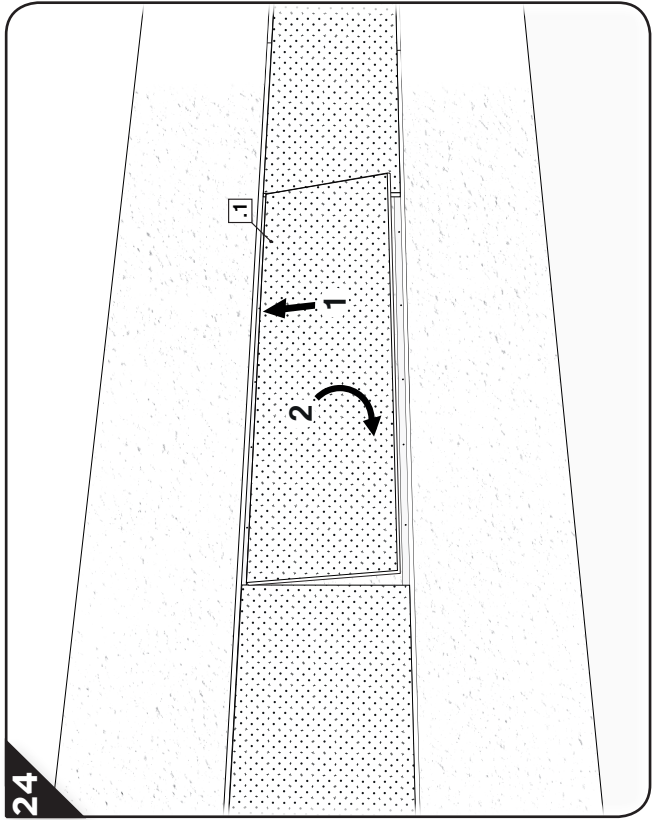



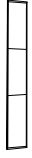
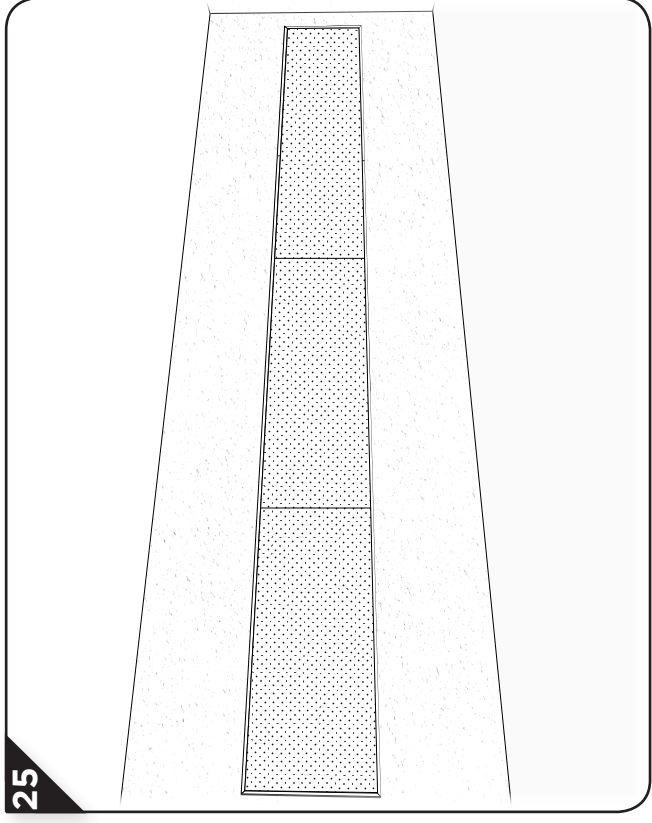





25

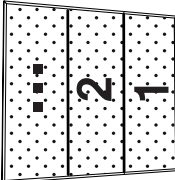

Acoustiroc®

GUIDE D'INSTALLATION POSES HORIZONTALES HORIZONTAL INSTALLATION GUIDE

- ▶ **MESURE & PREPARATION / PREPARATION & MEASUREMENT** ⇒  **1 - 3**
- ▶ **DECOUPE & INSTALLATION DES PROFILS / CUTTING & INSTALLING THE FRAME** ⇒  **4 - 8**
- ▶ **DECOUPE DES PANNEAUX / CUTTING THE PANELS** ⇒  **9**
- ▶ **INSTALLATION EMPILÉE / STACKED INSTALLATION** ⇒  **10 - 16**

- ▶ **INSTALLATION PANNEAU SEUL / SINGLE PANEL INSTALLATION** ⇒  **17 - 18**

- ▶ **INSTALLATION EN BANDEAU / ALIGNED INSTALLATION** ⇒  **19 - 25**
